



Available finish: Anthracite

Read these instructions before commencing installation. Please give these instructions to the owner/occupier after installation to retain for future reference/maintenance.

IP65 240V~50Hz 1W-1.2W

These fittings are Class II and do not require to be Earthed

**Important Information**

It is recommended that these luminaires are installed and fitted by a qualified electrician ensuring the installation complies with current IEE wiring regulations & local building control. These products are designed for connection to a 240V~50Hz supply. Any faulty, broken or damaged luminaires should be replaced immediately. KSR will not accept responsibility for any claims arising from a poor installation. Please Note: The limited warranty shall be deemed null and void in the following circumstances: Failure by the installer, end user or any third party to exercise caution to protect any covered product or part from outside damage, adverse temperature (normal operating ambient temperature -20 ~ +40°C), humidity conditions, fluctuations in the electrical system or physical abuse as well as failure related to workmanship in the installation of the products or parts.

**Important User Advice**

Always switch off and isolate the mains supply before installing or servicing. Do not use Megger or similar high voltage instruments. Due to the fact this luminaire contains electronic components that maybe damaged by high test voltages, they must be disconnected from the circuit before testing. To prevent damage to the luminaire, do not mix with conventional magnetic ballasts on the same electrical circuit. At the end of life the luminaire is classed as WEEE under directive 2014/30/EU and should be disposed of in accordance with local legislation.

**Installation Procedure**

Familiarize yourself with the luminaire, and ensure the mains power is turned off and safely isolated before installation. Unclip the front cover from the fitting to expose the clear diffuser Fig. 1. Remove the four diffuser retaining screws, remove the diffuser Fig. 2. Offer the luminaire up and mark the four fixing points, taking care not to damage other services drill the fixing holes. Feed the mains supply cable through the grommet and secure the luminaire to the wall using suitable screws for the substrate. Terminate the wiring into the terminal block, ensuring correct polarity Fig. 3. Replace the clear diffuser and tighten the four screws, do not overtighten these screws or distort the gasket Fig. 4. Clip the front cover back onto the luminaire, switch on the power and test the fitting Fig. 5.

Fig. 1

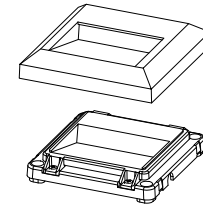

Fig. 2

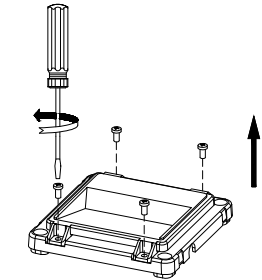

Fig. 3

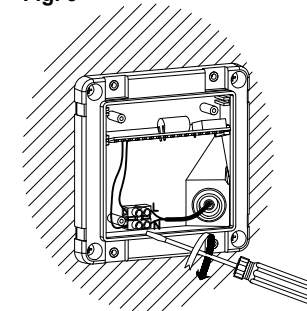

Fig. 4

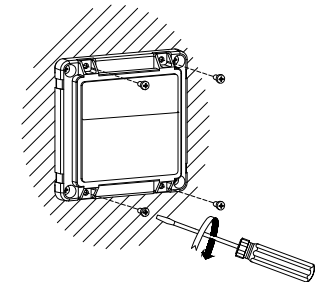
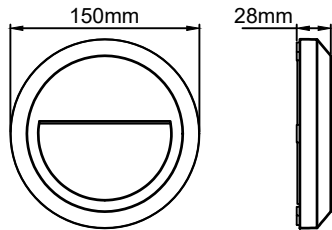
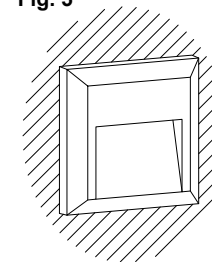
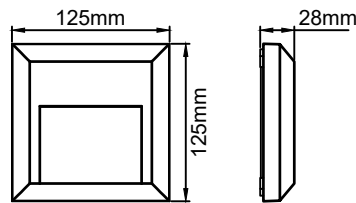

Fig. 5



KSR1335



KSR1336



<p><b>Lamp Details</b>                  KSR1335WW - 1.2W 3000K - 49 Lumens                  KSR1336WW - 1W 3000K - 42 Lumens</p>
<p><b>The light source of this luminaire is not replaceable; when the light source reaches its end of life the whole luminaire shall be replaced</b></p>

This product contains a light source of energy efficiency class G

KSR Lighting Aftersales: 023 92 674343  
 E-mail: aftersales@ksrlighting.com