



Available finish: Anthracite

Read these instructions before commencing installation. Please give these instructions to the owner/occupier after installation to retain for future reference/maintenance.

IP65 240V~50Hz 10W 4000K LED

These fittings are Class II and should not be Earthed

Important Information

It is recommended that these luminaires are installed and fitted by a qualified electrician ensuring the installation complies with current IEE wiring regulations & local building control. These products are designed for connection to a 240V~50Hz supply. Any faulty, broken or damaged luminaires should be replaced immediately. KSR will not accept responsibility for any claims arising from a poor installation. Please Note: The limited warranty shall be deemed null and void in the following circumstances: Failure by the installer, end user or any third party to exercise caution to protect any covered product or part from outside damage, humidity conditions, fluctuations in the electrical system or physical abuse as well as failure related to workmanship in the installation of the products or parts.

Important User Advice

Always safely isolate the mains supply before installing/servicing. Please note this luminaire is Non Dimmable. General maintenance and cleaning should be performed at least quarterly. Clean product outer using a damp cloth, the glass can be cleaned with hot soapy water, dried and buffed to a shine. Greasing screws and nuts with a suitable waterproof repellent will ensure the product gives you a long lasting trouble free life/finish. At the end of life the luminaire is classed as WEEE under directive 2014/30/EU and should be disposed of in accordance with local legislation.

Installation Procedure

Ensure mains supply is safely isolated. Locate a suitable location for the luminaire, use the mounting bracket as a template to drill fixing holes. Secure the bracket into position using suitable fixings. Prepare wiring, using suitable cable for the application. When securing this product to a wall, please remember to allow enough slack cable to tilt the luminaire to its final resting position. Never allow the mains cable to become strained. Terminate the wiring as per Fig.1 using a suitable IP rated connector/junction box. Adjust the angle of tilt to the required position and tighten bolts to a maximum torque of 7.3Nm. Position the PIR in the direction required and tighten the screw on the knuckle ensuring it is tight, always re-check after repositioning. If this is not tightened the water ingress protection will be reduced and can cause premature failure. Turn mains supply on and test luminaire. Pass on these instruction sheets to the owner/occupier. To adjust the settings you require on the PIR see overleaf.

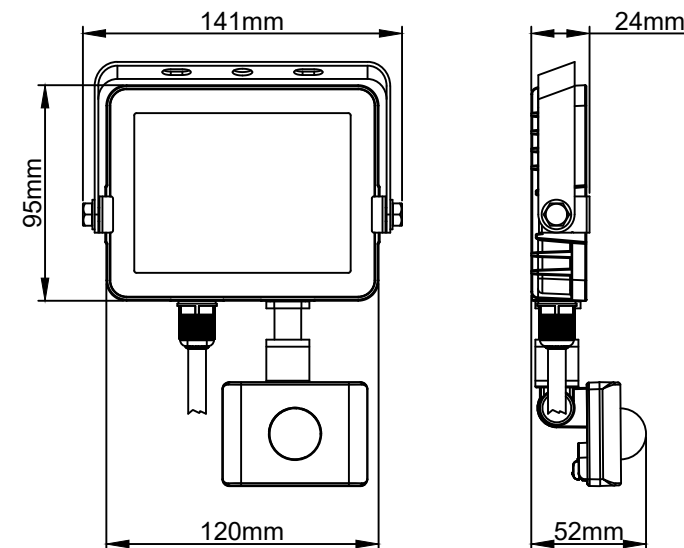
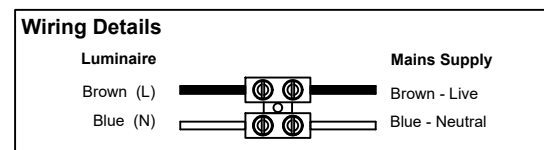

Fig.1



Lamp Details



Lamp: 10W - 4000K
Lumen Output: 985 lumens
CRI: >Ra82
Beam Angle: 108°

The light source of this luminaire is not replaceable; when the light source reaches its end of life the whole luminaire shall be replaced

This product contains a light source of energy efficiency class E

KSR Lighting Aftersales: 023 92 674343
 E-mail: aftersales@ksrlighting.com



Read these instructions before commencing installation. Please give these instructions to the owner/occupier after installation to retain for future reference/maintenance.

Description of Operation

This floodlight comes complete with an passive infrared detector. The lamp switches on when movement in the surrounding area is detected or when natural day light becomes dusk. Ensure to replace any cracked shield / glass.

Operation Mode

When power is switched on, the PIR detector enters into the warm up period (approx 15-30 seconds), the PIR will then change to the AUTO MODE automatically, during the AUTO MODE walk testing can be easily carried out.

Walk Testing

Before walk testing, please put the LUX control to the day position (☀) and the TIME control to minimum (fully clockwise). Once the PIR sensor receives a valid trigger signal (such as body movement) within its detection area, the load / lamp will be turned on for a duration time, You will obtain the desired detection area by walking slowly through the area to be covered.

Adjusting the Lux Control Level

The LUX control module has an in built sensing device (photocell) that detects daylight (☀) and darkness (☾) Rotating the LUX control anti-clockwise will take it from light to dark, set at desired level.

Note: You will need to wait 5 secs for the stability of the photocell (CDS) when adjusting the LUX control.

Adjusting the Duration Time

The length of time sensor remains on after activation can be adjusted from 10 secs to 9 mins. Rotate the TIME control clockwise to increase the duration.

Note: Once the load has been triggered by the PIR detector any subsequent detection will restart the time period.

Adjusting the Sensitivity

With this control the sensitivity of the detector can be adjusted, turn the SENS control anti-clockwise to increase the sensitivity.

Manual Override

With the floodlight powered on, switch the power off and then back on in less than 3 seconds.

This will override the sensor and the light will stay on.

To revert back to auto mode power off the floodlight for more than 5 seconds and power back on.

Please Note: After adjusting the PIR please make sure the screw on the knuckle joint that allows you to adjust the angle of the PIR is tightened to ensure the fitting retains it's IP65 rating failure to do this could result in water ingress and premature failure of the luminaire.

PIR Adjustments

TIME

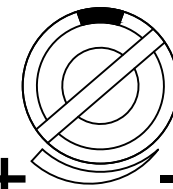

SENS

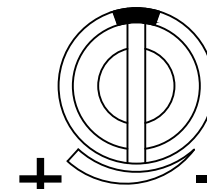

LUX

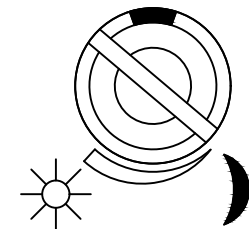

PIR Specification

Detection Range: 120°
Detection Distance: 2~10m(adjustable)
Time Delay: 10sec ±5sec ~ 7min ±2min (adjustable)
Ambient Light: <3 ~ 2000 LUX (adjustable)
Detection Motion Speed: 0.6-1.5m/s
Working Temperature: -10°C ~ +40°C
Working Humidity: <93%RH
Installation Height: 1-3m
Override Mode: Yes
Parasitic Power: <0.5W

KSR Lighting Aftersales: 023 92 674343
 E-mail: aftersales@ksrlighting.com

