



Available finish: Anthracite

Read these instructions before commencing installation. Please give these instructions to the owner/occupier after installation to retain for future reference/maintenance.

IP65    240V~50Hz 30W 4000K LED

These fittings are Class II and should not be Earthed

Important Information

It is recommended that these luminaires are installed and fitted by a qualified electrician ensuring the installation complies with current IEE wiring regulations & local building control. These products are designed for connection to a 240V~50Hz supply.

Any faulty, broken or damaged luminaires should be replaced immediately.

KSR will not accept responsibility for any claims arising from a poor installation.

Please Note: The limited warranty shall be deemed null and void in the following circumstances: Failure by the installer, end user or any third party to exercise caution to protect any covered product or part from outside damage, humidity conditions, fluctuations in the electrical system or physical abuse as well as failure related to workmanship in the installation of the products or parts.

Important User Advice

Always safely isolate the mains supply before installing/servicing.

Please note this luminaire is Non Dimmable.

General maintenance and cleaning should be performed at least quarterly.

Clean product outer using a damp cloth, the glass can be cleaned with hot soapy water, dried and buffed to a shine.

Greasing screws and nuts with a suitable waterproof repellent will ensure the product gives you a long lasting trouble free life/finish.

At the end of life the luminaire is classed as WEEE under directive 2014/30/EU and should be disposed of in accordance with local legislation.

Installation Procedure

Ensure mains supply is safely isolated. Locate a suitable location for the luminaire, use the mounting bracket as a template to drill fixing holes. Secure the bracket into position using suitable fixings. Prepare wiring, using suitable cable for the application. When securing this product to a wall, please remember to allow enough slack cable to tilt the luminaire to its final resting position. Never allow the mains cable to become strained.

Terminate the wiring as per Fig.1 using a suitable IP rated connector/junction box.

This product can be used as a wall washer if required always keep the cable gland at the bottom of the floodlight facing the ground.

Please note that the fitting is only suitable for wall washing/uplighting at a 45° angle, this is to prevent water sitting on the fitting for prolonged periods of time Fig.2.

Finally, adjust the angle of tilt to the required position and tighten bolts to a maximum torque of 7.3Nm.

Turn mains supply on and test luminaire.

Fig.2

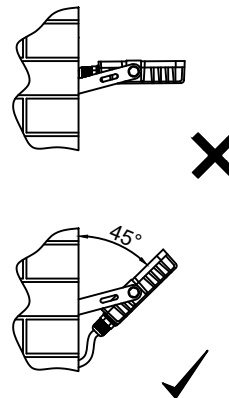

Wall Installation

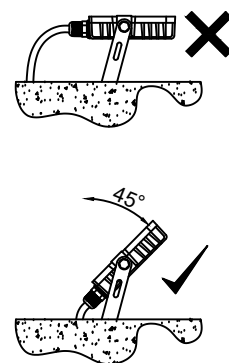

Ground Installation

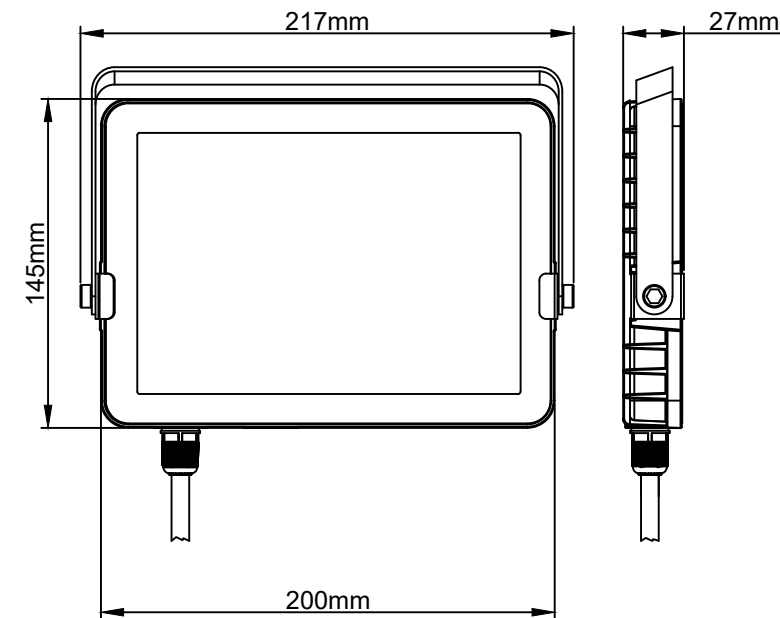
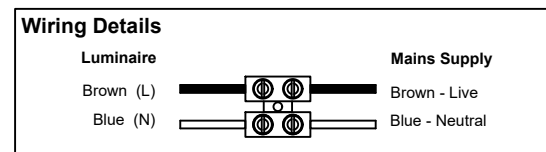



Fig.1



Lamp Details



Lamp: 30W - 4000K
Lumen Output: 3205 lumens
CRI: >Ra82
Beam Angle: 105°

The light source of this luminaire is not replaceable; when the light source reaches its end of life the whole luminaire shall be replaced

This product contains a light source of energy efficiency class E

KSR Lighting Aftersales: 023 92 674343

E-mail: aftersales@ksrlighting.com