



Read these instructions before commencing installation. Please give these instructions to the owner/occupier after installation to retain for future reference/maintenance.

IP65 IK10 240VAC~50HZ

These Sensors are Class II and do not require an Earth connection

Important Information

It is recommended that luminaires are installed and fitted by a qualified electrician ensuring the installation complies with current IEE wiring regulations & local building control. These products are designed for connection to a 240V 50Hz supply. Any broken or damaged parts should be replaced as soon as possible. KSR will not accept responsibility for any claims arising from a poor installation.

Installation Guidelines

Secure the Microwave sensor to the lowbay using fixings provided.
Terminate your mains input cable into the L & N terminals, then connect the luminaire wires into the L & N terminals on the sensor.

On initial installation it is advised you leave the time setting to 5 Seconds and the Lux setting on to disable mode, with the sensitivity set to max (100%) This will allow you to test and set up the sensor as required.

Time - This sensor can switch the lighting from a minimum of 5 Seconds to a maximum of 30 minutes, carefully turn the time dial to the required time.

Lux - This sensor will activate between daylight and 2 Lux, in order to achieve the required 'on' time it is recommended that the sensor is set to 50 Lux and wait 24 hours, after this period you can adjust the Lux control to up or down accordingly.

Sensitivity- The sensor will activate between 1m and 6m range, if the sensor triggers movement outside the required area, reduce the sensitivity to compensate.

Position - Ensure you position the sensor in a location suited to the the required activation point, this may not be central to any space. Avoid placing the sensor near heating vents or highly reflective surfaces as this may cause unwanted triggering.

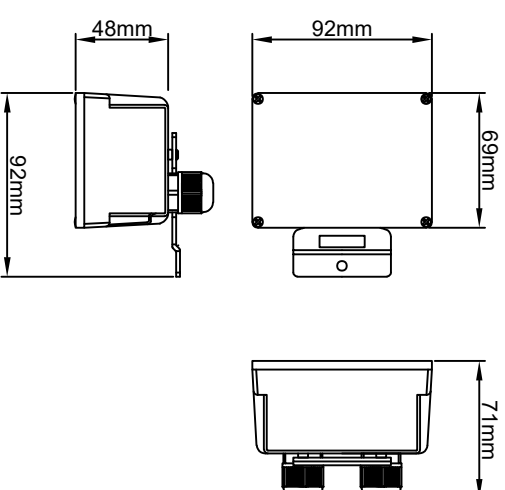
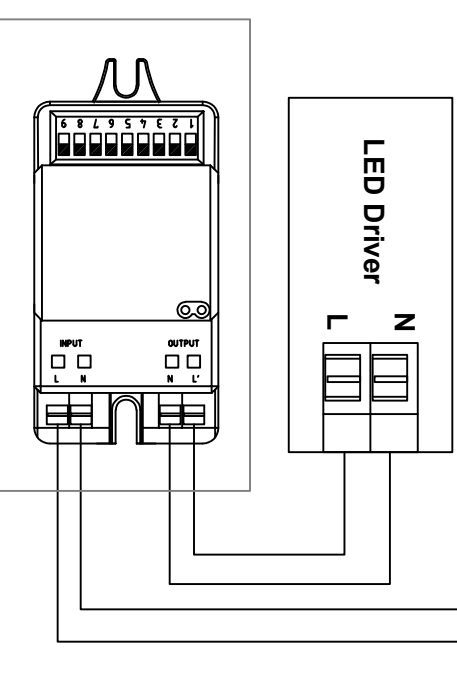
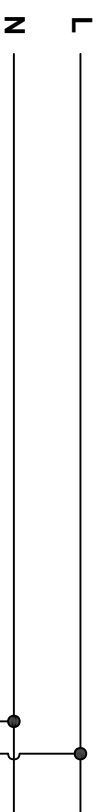

KSR Lighting Aftersales: 023 92 674343
E-mail: aftersales@ksrlighting.com



Read these instructions before commencing installation. Please give these instructions to the owner/occupier after installation to retain for future reference/maintenance.

IP65 IK10 UK € 240V~50HZ 400W Max

Step 1 - After a suitable area is identified for the sensor fitting begin to wire sensor to driver and mains supply.

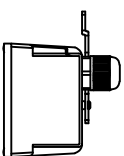
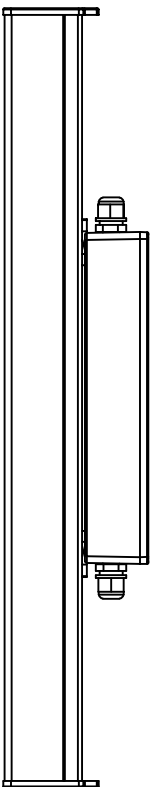

Step 3 - Using the fixings provided secure sensor onto lowbay by fastening the screw into the channel located at the top, the lock nut will grip in place when the screw is tightened fully.

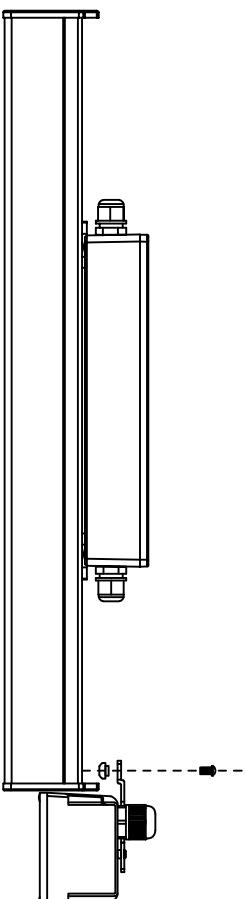

Step 2 - Proceed to fit sensor bracket onto luminaire by lining up cut out of the bracket to the edge of Lowbay

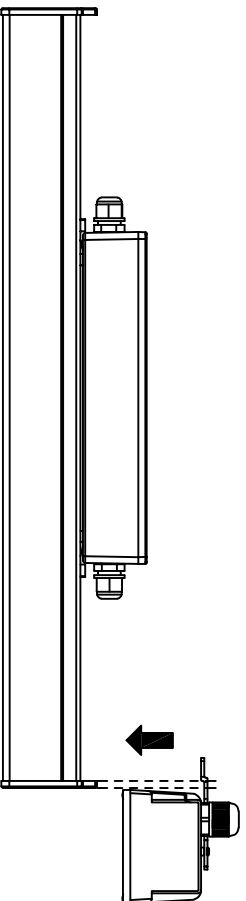

Step 4 - With the microwave fastened in place, proceed to remove cover by removing the 4 locking screws and set microwave sensor via the dip switches (for settings see sensor set up instruction) for a walk test to ensure the fitting and sensor are working as expected. After testing set sensor to suit application and replace cover.

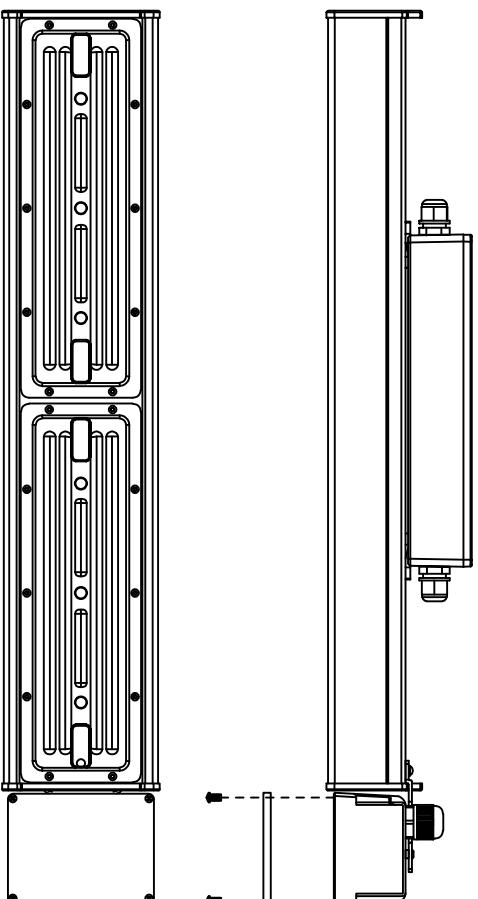



Read these instructions before commencing installation. Please give these instructions to the owner/occupier after installation to retain for future reference/maintenance.

IP65 IK10 240V~50Hz 400W Max

This Microwave sensor is a motion activated switch, it will turn the light on when movement is detected, then hold the light on for the determined amount of time, after which the light will turn off.

Using the Dip Switches on the sensor, set it up to your preferred Detection area, Hold Time & Daylight level.

Microwave sensors will detect movement through certain materials, if this occurs reduce the detection area until any nuisance triggering stops.

Max Load - 400W (Inductive)(LEDs)
Max Load - 800W (Resistive)

1 - Detection Area

Detection area can be reduced by selecting the combination on the Dip Switches, following the guide as shown here.

I	1	2	3	
II	○	●	●	100%
III	●	○	●	75%
IV	○	○	●	50%
V	○	○	○	25%
VI	○	○	○	10%

2 - Hold Time

Hold time means the time period you would like the light to remain 'on' once no movement is detected.

I	4	5	6	
II	○	●	●	5s
III	●	○	●	30s
IV	○	○	●	90s
V	○	○	○	3min
VI	○	○	○	20min
	○	○	○	30min

3 - Daylight Sensor

The daylight sensor can be set to bring the light 'on' at specific daylight levels. To have the sensor function in daylight set the Dip Switches to Disable.

I	7	8	9	
II	●	●	●	2 Lux
III	○	●	○	10 Lux
IV	○	○	○	25 Lux
V	○	○	○	50 Lux
VI	○	○	○	Disable

Troubleshooting

Issue	Cause	Solution
The load will not illuminate	Incorrect daylight threshold setting selected Load has failed (driver or LED array) No mains power detected	Adjust setting and retest Replace load Switch on power
The load is permanently illuminated	Continuous movement in the detection area	Check detection area setting
The load will not illuminate despite movement	The lamp (containing sensor) is installed in an area too close to reflective surface, i.e Metal, Glass or Concrete walls. Speed of moving object is not in the range of 0.5-3m/s or the detection radius is too small	1. Make sure installation area suitable with at least 30cm space between lamp and surrounding reflective surfaces 2. Reduce Sensitivity (detection area) Check Detection area setting

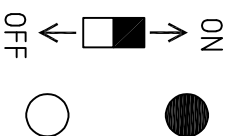
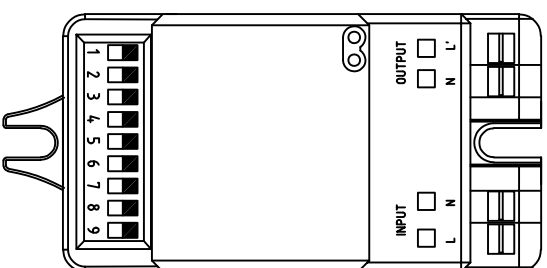

The Sensor is designed for installation heights of 3-6m

Recommended Installation heights

For Wall mounting the height is 1.5m
For Ceiling mounting the height is 3m

Detection Zone Max. (D x H) : 12m x 6m
Detection Angle: 150° (wall Installation)
360° (ceiling Installation)

